

Varenummer: 0125067
 Beskrivelse: Seeger låsering SP50
 Fjederstål

Mål

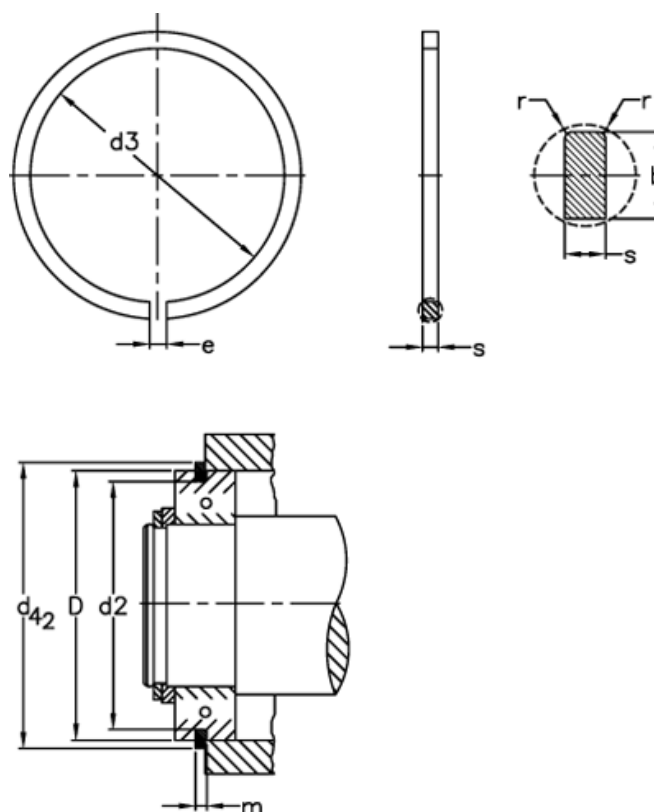

b	= 4.04	FRg kN	= 2.60	tol	= -0.15
Betegnelse	= SP 50	FR kN	= 13.3	tol	= -0.1
D	= 50	g	= 2.0	tol	= -0.25
d2	= 47.60	K kN-mm	= 24.3	tol	= 0.3
d3	= 46.7	m	= 1.35	tol	= 0.5
d42	= 55.7	n abl x 1000	= 6.0	vægt kg/1000	= 5.8
e	= 4	r min	= 0.4		
FN kN	= 30.6	s	= 1.12		